

新鄂重 湖北重装

中国性价比最高的卷板校平装备制造商



官方微信



官方抖音

湖北重装重工装备有限公司

HUBEI HEAVY INDUSTRY EQUIPMENT CO.,LTD

服务热线:400-185-7998

手机:18671110001

电话:0711-3891561

网址:www.ezhong-china.com

邮箱:e-zhong@foxmail.com

邮政编码:436000

地址:湖北省鄂州市经济开发区四海大道特一号

No.1 Sihai Ave,Ezhou Industrial Estate,Hubei Province,China



中国金属成形装备品牌企业

湖北重装

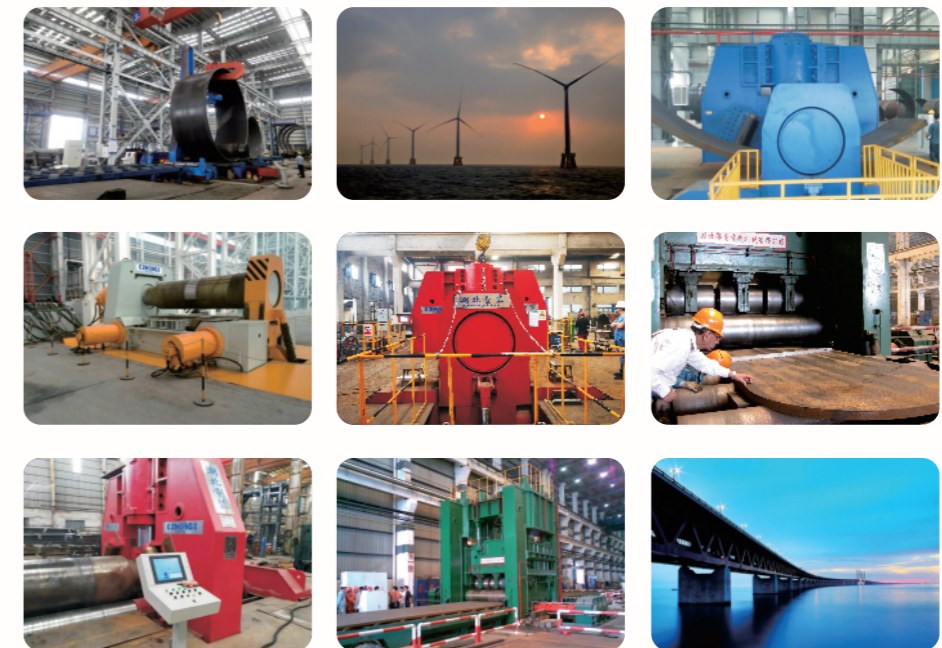

传承 价值 创新 未来

www.ezhong-china.com



Company Profile 公司简介



官方视频

湖北重装重工装备有限公司坐落于古城吴都·湖北省鄂州市，是原一机部定点生产卷板机、矫平机重型锻压整形设备企业之一鄂重集团，历经改革、改组、改制后成立的具有独立法人资格的制造型公司。

公司在大型水平下调式三辊卷板机、全液压变几何参数卷板机、数控四辊卷板机、数控板材辊式矫平机等板材弯曲加工设备制造方面积累了丰富的经验。为国家重大工程和重点项目提供了大量设备，如三峡工程、鸟巢、国家大剧院、首都机场第三航站楼等都是选用鄂重牌产品替代国外产品。

公司拥有多项具有自主知识产权的专利技术，是湖北省高新技术企业。公司建有湖北省省级工程中心和湖北省重型卷板机研究中心，是湖北省博士后产业化基地，先后获得“湖北省科学技术进步奖”、“湖北省技术发明奖”、“中国机械工业联合会科学技术进步奖”等奖项，多种规格的大型水平下调式三辊卷板机和矫平机获“国家级新产品证书”，并纳入“国家级火炬计划项目”。

鄂重人历经风雨，鄂重人开创了历史，鄂重人勇于创新，鄂重人在创造未来。



Our Company

Hubei heavy industry equipment Co., Ltd. is located in the ancient city of Wudu - Ezhou City, Hubei Province. It is one of the heavy forging and shaping equipment enterprises designated by the former First Machinery Department to produce rolling machines and levelers. It is a manufacturing company with independent legal personality established after reform, reorganization and restructuring.

The company has accumulated rich experience in the manufacturing of plate bending equipment, such as large-scale horizontal three roll bending machine, full hydraulic variable geometry bending machine, CNC four roll bending machine, CNC plate roller leveler, etc. It has provided a large number of equipment for national major projects and key projects, such as the Three Gorges project, the bird's nest, the National Grand Theater, the third terminal building of the capital airport, etc., all of which use EZHONG brand products to replace foreign products.

The company has a number of patents with independent intellectual property rights, is a high-tech enterprise in Hubei Province. The company has Hubei Provincial Engineering Center and Hubei heavy rolling machine research center, which is the post doctoral industrialization base of Hubei Province. It has won the "Hubei Province Science and Technology Progress Award", "Hubei Province Technology Invention Award", "China Machinery Industry Federation science and Technology Progress Award" and other awards, A variety of specifications of large-scale horizontal down regulating three roll plate bending machine and leveler have been awarded the "national new product certificate" and included in the "National Torch Program project".

The people of EZHONG have gone through trials and tribulations. They have created history. They have the courage to innovate. They are creating the future. Hubei heavy equipment inherits the brand and innovates the future!

质量保证

结构件退火



工作辊调质



工作辊加工



目录

01 水平下调式三辊卷板机 THREE ROLL BENDING MACHINE

1. 鄂重卷板机技术引领 Hubei rewinding machine technology led 06
2. 液压数控中心距可调三辊卷板机 Plate Bending machine with variable center distance 09
 - 液压全驱动重型三辊卷板机 Hydraulic three roll plate rolling machine
 - 双驱动重型三辊卷板机 Hydraulic three roll plate rolling machine
3. 风塔卷板机 Hydraulic three roll plate rolling machine 18
4. 船用卷板机 Hydraulic three roll plate rolling machine 22

02 四辊卷板机 FOUR ROLL BENDING MACHINE

1. 全自动薄板四辊卷板机 Automatic four sheet rolling machine 25
2. 全液压厚板四辊卷板机 hydraulic four plate rolling machine 27

03 板材校平机 PLATE LEVELER

1. 厚板重型校平机 Heavy plate leveler 29
2. 金属复合板材校平机 Composite plate leveler 31
3. 高强度工程机械校平机 Leveling machine for high strength steel construction machinery 35
4. 高强度薄板校平机 Leveling machine for high strength steel sheet 37
5. 高强防弹钢板校平机 High strength bulletproof steel plate leveler 40

04 压力机 PRESS

1. 卧式轮轴压装机 Horizontal axle press 42
2. 油压机 hydraulic press 44

05 型材弯曲机 PROFILE BENDING MACHINE

T

扫视频,更直观



水平下调三辊卷板机

Three Roll Plate Rolling Machine 水平下调式三辊卷板机

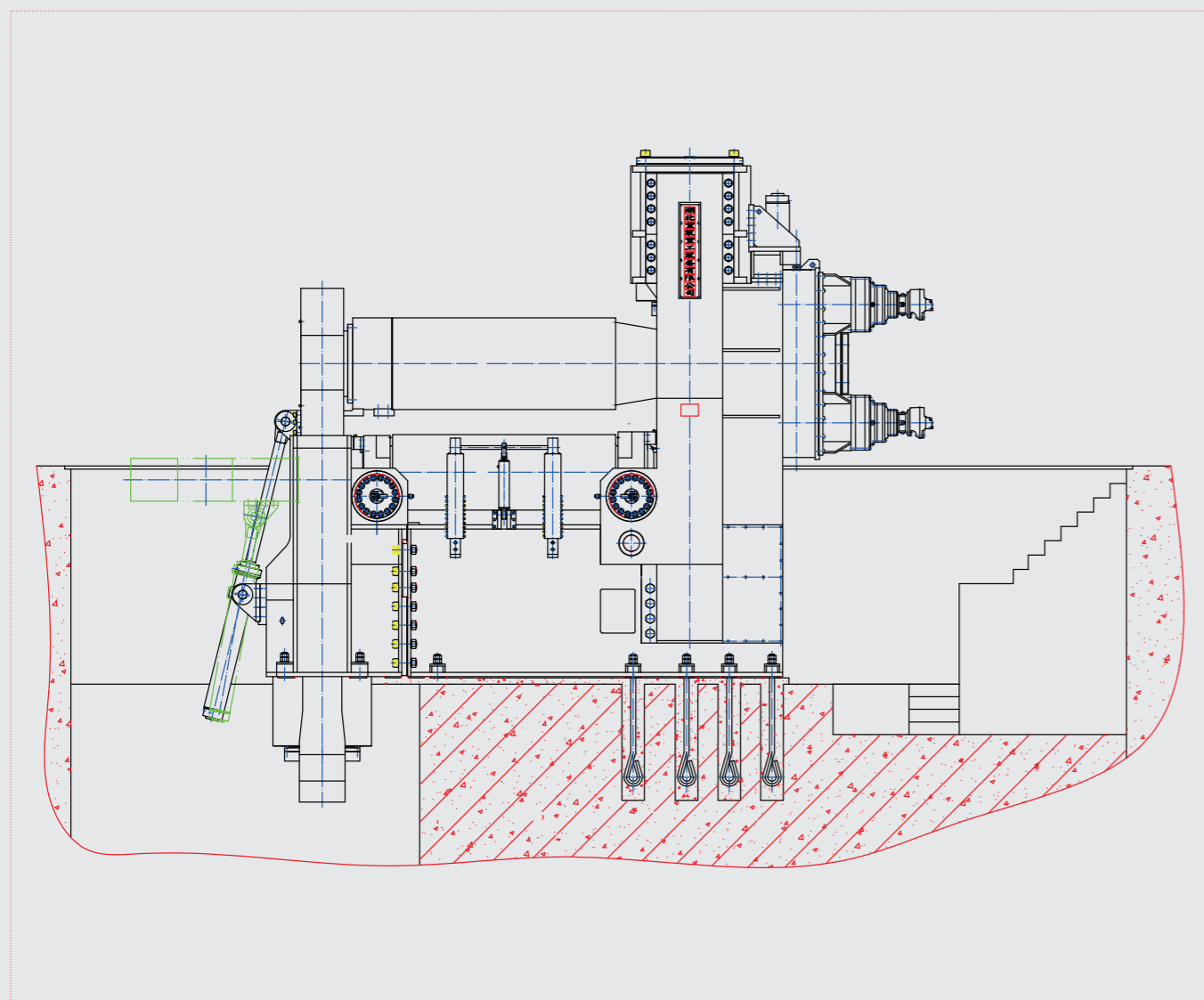

EZHONG

鄂重卷板机·行业技术引领

鄂重多年来与国际同行进行交流合作,不断提升技术水平,与国际同步。

Over the years, EZHONG has conducted exchanges and cooperation with its international counterparts, constantly upgrading its technical level and keeping pace with the international community.



比利时LVD及黄锻YSD领导及技术专家来公司交流
Belgian LVD and yellow forging YSD leaders and technical experts to exchange



与世界上卷板机技术最出色的瑞士豪斯勒公司HAEUSLER专家交流
Communicate with the expert of HAEUSLER, the Swiss company with the most excellent technology in the world



意大利法圣FACCIN技术专家马萨来公司交流 Technical expert MASA of FACCIN in Italy

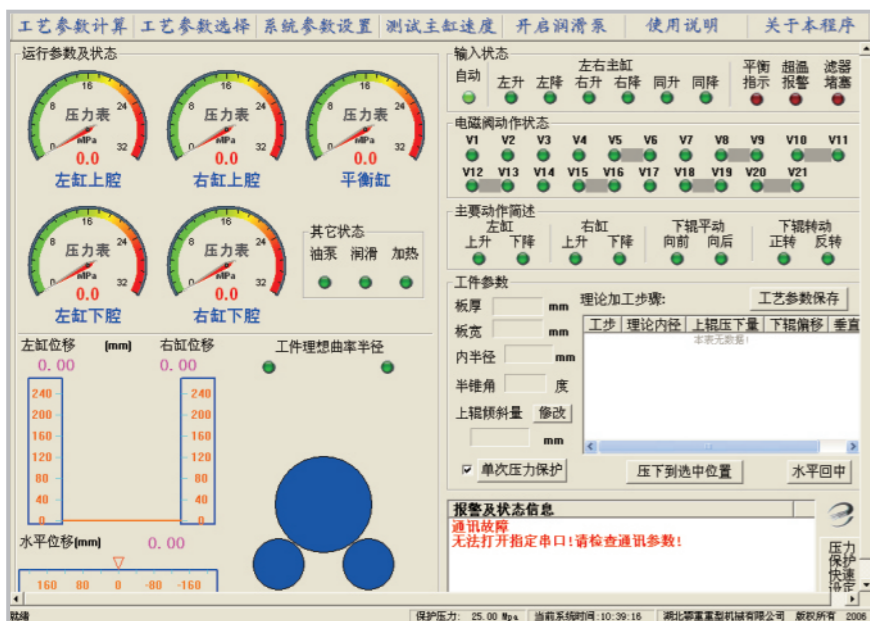

鄂重卷板机计算机系统可以进行计算、数据存储、报警、网络连接等智能化设置。

The computer system of plate bending machine can be set up intelligently, such as calculation, data storage, alarm, network connection, etc. .

经华中科技大学、武汉理工大学采用SolidWorks三维、二维模型、Cosmos等现代化手段,进行上万次设计可靠性验证、结构优化、应力应变直观演示分析。

By means of Solid Works 3D, 2D model, Cosmos and other modern means, thousands of times design reliability verification, structural optimization, visual demonstration and analysis of stress and strain were carried out by HUAZHONG University of Science and Technology and Wuhan University of Technology.

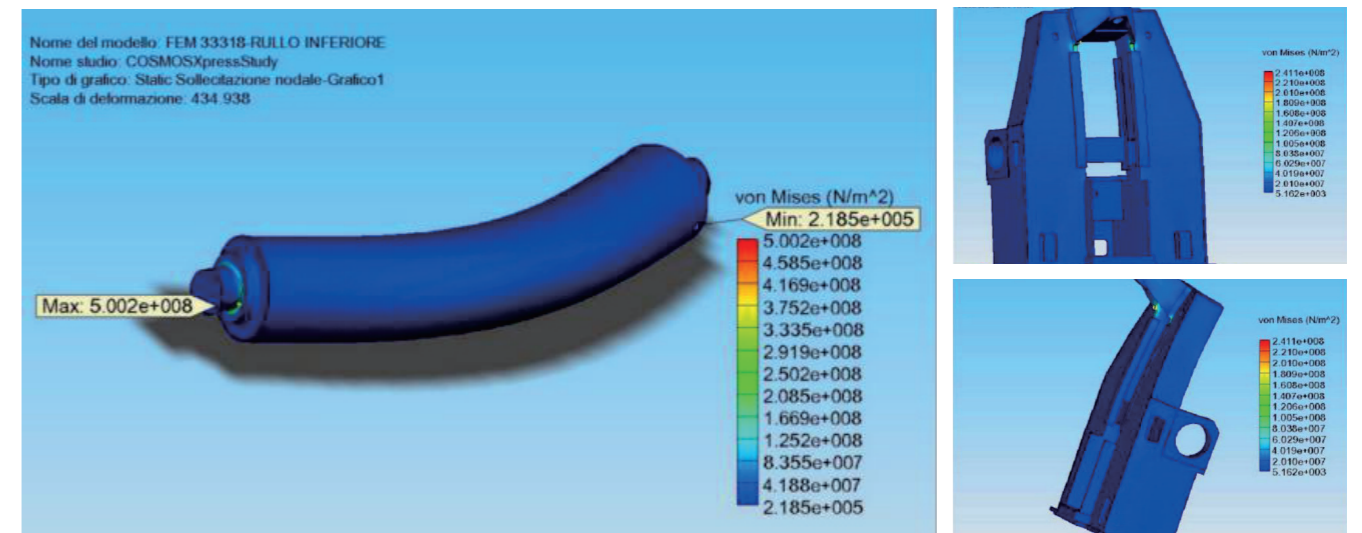
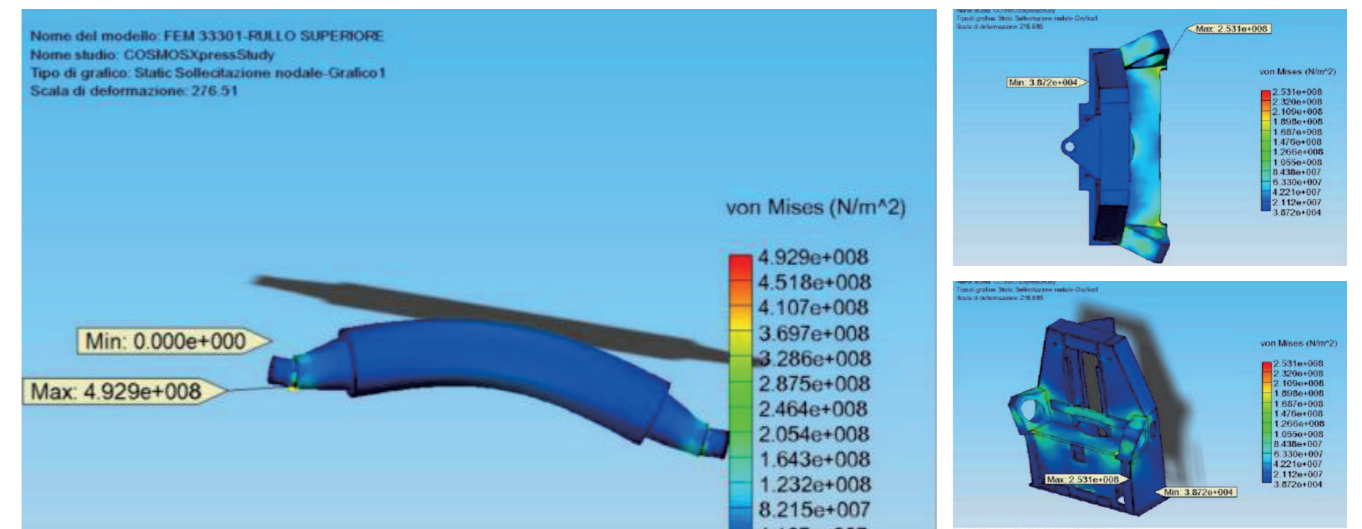
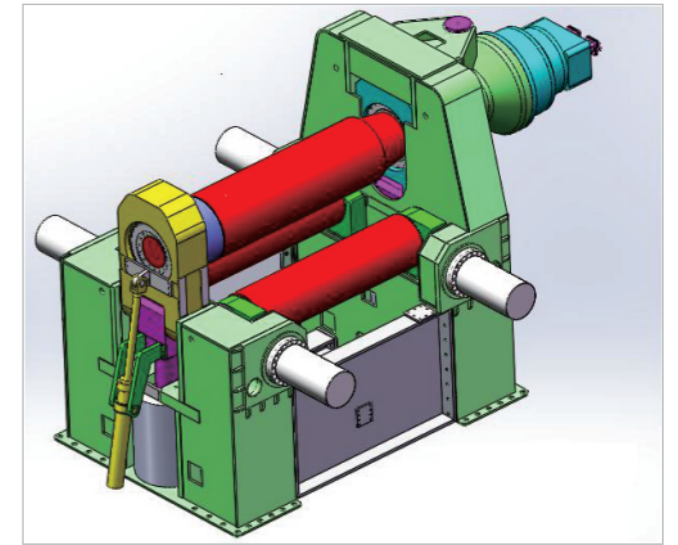

■ 液压数控中心距可调三辊卷板机

液压中心距可变卷板机是一台具有大中型厚板预弯和卷制不同形状产品的液压三辊卷板机。该型号不同于传统的型号，因其每根下辊均可独立水平移动，可产生任意所需节距，其安装马达的上辊可垂直移动。由于这些辊产生的不同几何形状，机器可按需菱形或不对称的机器来使用。增加下辊间的距离的可能性决定了：只在一台机器内可相当于多台机器的功能，扩大了转制范围。

Hydraulic Center Distance Variable Plate Bending machine is a hydraulic three-roller plate bending machine with medium/large thickness plate pre-bending and rolling products of different shapes. This model is different from the traditional model, because each lower roller can be moved independently horizontally, can produce any desired pitch, and the upper roller of the motor can be moved vertically. Because of the different geometry these rollers produce, the machine can be used as a four-roller machine, a diamond-shaped or an asymmetric machine as needed. The possibility of increasing the distance between the lower rollers determines that the same force and power as that of a double prebending machine can be used in only one machine.



EZW11S-120×3200数控可变中心距三辊卷板机

受控的下辊的移动使得预弯操作可非常容易地进行。

The controlled movement of the lower rollers makes pre-bending very easy.

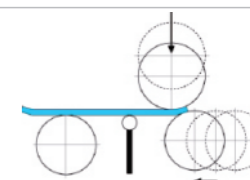

下辊间距离的减小可更好地拖动板，以利后续弯曲较小直径和厚度的产品，并有助于对必须要焊接的弯曲板的测量。

The reduction of the distance between the lower rollers enables better traction of the plate for subsequent bending of smaller diameter and thickness products, and facilitates the measurement of the bending plates that must be welded.

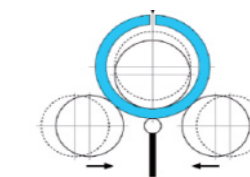

增加下辊中心距更容易于弯曲厚板和增加校圆能力。

Increasing the distance between the lower rollers makes it easier to bend the thick plate.

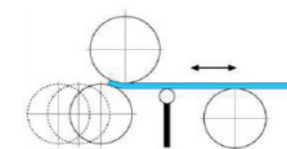

在预弯时，钢板保持在水平位置，这样保证对操作员有更好的安全条件。

In the pre-bending, the steel plate is kept in a horizontal position, thus ensuring better safety conditions for the operator.

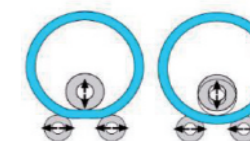

EZW11S-150×3200数控可变中心距三辊卷板机

EZW11S						
MODEL 型号	Useful Length 卷板宽度 mm	Without Prebending 无预弯 mm	With Prebending 预弯 mm	Motor Power 电机功率 KW	Working Speed 卷板速度 m/min	Dimensions 外形尺寸 mm
EZW11S-35×2000	2500	35	25	37.5	1.5-5	5450×2800×2000
EZW11S-40×2000	2500	40	35	48	1.5-5	6000×2800×2000
EZW11S-50×2000	2500	50	40	52	1.5-5	6100×2800×2200
EZW11S-60×2000	2500	60	50	73.5	1.5-4	6900×3100×2650
EZW11S-65×2000	2500	65	55	73.5	1.5-4	7050×3350×2700
EZW11S-30×3000	3000	30	20	37.5	1.5-5	5950×2800×2000
EZW11S-35×3000	3000	35	25	48	1.5-5	6500×2800×2000
EZW11S-45×3000	3000	45	30	52	1.5-5	6600×2800×2200
EZW11S-50×3000	3000	50	35	73.5	1.5-4	7400×3100×2650
EZW11S-60×3000	3000	60	40	73.5	1.5-4	7550×3350×2700
EZW11S-25×4000	4000	25	15	37.5	1.5-5	6950×2800×2000
EZW11S-30×4000	4000	30	18	48	1.5-5	7500×2800×2000
EZW11S-35×4000	4000	35	20	52	1.5-5	7600×2800×2200
EZW11S-40×4000	4000	40	25	73.5	1.5-4	8400×3100×2650
EZW11S-45×4000	4000	45	30	73.5	1.5-4	8550×3350×2700
EZW11S-50×4000	4000	50	40	52+15	4.3	8750×3550×2950
EZW11S-60×4000	4000	60	50	60+15	4	9100×3900×3500
EZW11X-70×3200	3200	70	60	60+24.1	3.40	7980×3320×3680
EZW11X-80×3200	3200	80	70	60+32.2	4.00	8040×3950×3940
EZW11X-90×3200	3200	90	80	74+32.2	3.36	8280×3990×4470
EZW11X-100×3200	3200	100	90	104+32.2	3.50	8600×4160×4490
EZW11X-110×3200	3200	110	100	110+39.2	4.00	8860×4160×4960
EZW11X-120×3200	3200	120	110	126+39.2	3.60	8880×4360×4960
EZW11X-130×3200	3200	130	115	126+39.2	3.60	9070×4690×6100
EZW11X-140×3200	3200	140	125	126+39.2	3.60	10350×4990×6330
EZW11X-150×3200	3200	150	135	150+84.2	3.50	10430×4970×5850
EZW11X-160×3200	3200	160	140	150+79.2	3.20	10620×5450×6400
EZW11X-170×3200	3200	170	150	220+84.2	3.12	10950×5290×6360
EZW11X-180×3200	3200	180	170	220+93.7	3.12	10950×5920×6360
EZW11X-200×3200	3200	200	180	220+93.7	3.36	12100×6160×7460
EZW11X-150/220×3200	3200	150/220	130/180	220+89	3.12	10930×5900×6640
EZW11X-160/250×3200	3500	165/250	145/220	220+95	3.12	11480×5720×6880
EZW11X-200/300×3200	3500	200	180	665	3.34	12180×6270×7400
EZW11X-240/280×3200	3500	240	215	284+89	3.25	12200×6650×7600
EZW11X-270/360×3200	3500	270/230	240/330	597.5	3.25	12490×7070×8580

EZHONG has the right to revise the product feature ,figuration,specification and information without advance notice
鄂重机器技术参数可能有改变,解释权在鄂重。

关于卷锥

卷板机的设计可用液压倾斜的下辊(如需要液压倾斜也可在上辊)和应用支托设备实现锥形加工。

The design of the plate bending machine can be accomplished by using the hydraulic inclined lower roller (or the upper roller if hydraulic inclined) and the supporting equipment.

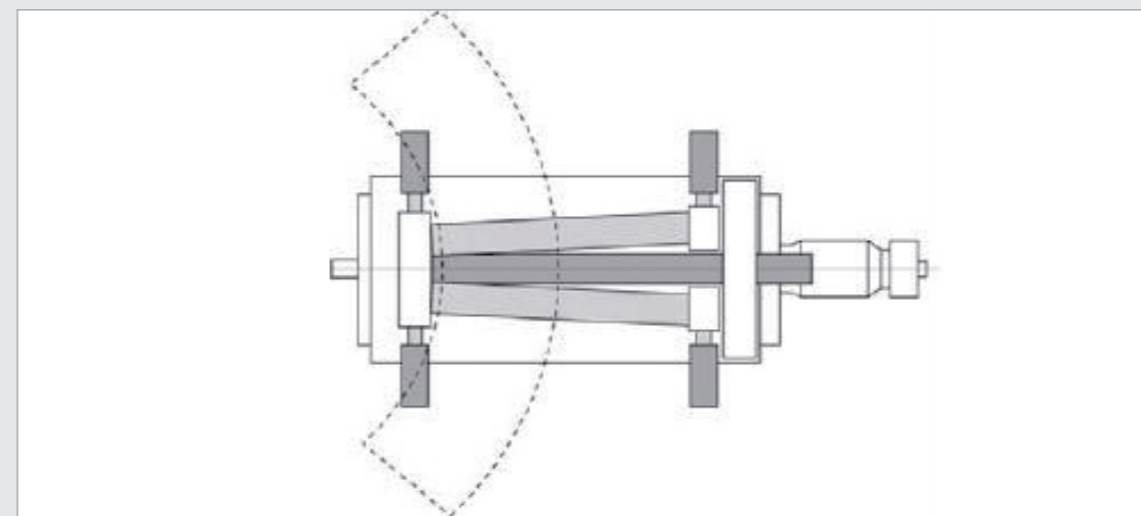

液压全驱动重型三辊卷板机

液压全驱动水平下调式三辊卷板机，采用右主油缸采用上置，左主油缸下置式结构。该机三个工作辊均为主驱动辊，上辊由液压马达通过行星减速机减速带动回转，下辊由液压马达通过行星减速机减速带动回转，行星驱动装置与卷辊轴直接耦合，可以大幅度减少负载损失(无用功)，使尽可能大的功(有用功)用于卷板；上辊的升降采用液压传动，升降位移由计算机控制，自动调平，屏幕显示，同步精度±0.2mm。下辊水平移动采用机械传动，水平移动通过蜗轮减速机减速，经螺杆、螺母副转换为直线运动带动。翻倒架的倾倒和复位采用液压传动，上辊的尾部装有液压平衡机构，可以方便卸出卷制后的工件及筒体。设有固定式操作台和遥控按钮盒各一个，方便工人使用。设有安全联锁装置，使操作更加安全。该机操作简单、维修方便，卷制精度高，是一种先进实用的大型卷板设备。

The horizontal downward adjustment type three roller plate bending machine adopts the right main oil cylinder to adopt the upper position and the left main oil cylinder to adopt the lower position structure. The three working rollers of the machine are all the main driving rollers. The upper roller is driven by the hydraulic motor through the planetary reducer, and the lower roller is driven by the hydraulic motor through the planetary reducer. The planetary driving device is directly coupled with the roll shaft, it can greatly reduce the load loss (useless work) and make as much work (useful work) as possible to be used in the plate bending. The lifting of the upper roller is driven by hydraulic pressure, and the lifting displacement is controlled by a computer. The screen shows that the synchronizing precision is ± 0.2 mm. The Horizontal Movement of the Lower Roller is driven by mechanical transmission. The horizontal movement is decelerated by the worm gear reducer and converted into linear movement by the screw and nut pair. The tilting and reposition of the turnover frame are driven by hydraulic pressure, and the tail of the upper roller is provided with a hydraulic balance mechanism, which can conveniently unload the rolled work piece and the cylinder body. A fixed operating table and a remote control button box are provided for the convenience of workers. It is equipped with safety interlock device to make the operation safer. The utility model has the advantages of simple operation, convenient maintenance and high rolling precision, and is an advanced and practical large plate bending equipment.

EZW11S-270/360x3500水平下调三辊卷板机张家港化工机械厂

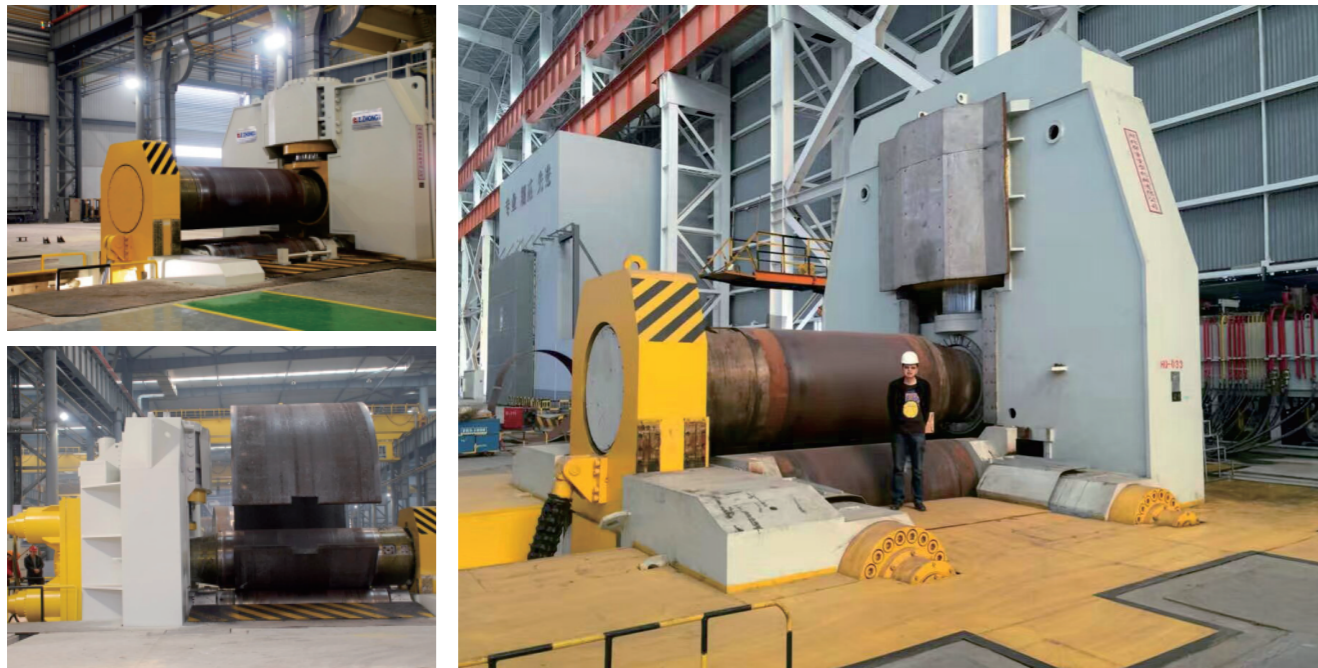

性能特点

- ▲ 压下油缸内置：压下油缸内置于床身。解决了目前下置压下油缸活塞杆外露带来的卷制过程中工件氧化皮堆积造成的活塞杆拉伤问题；实现了上置压下油缸和下置压下油缸均采用无杆腔工作，减少了高压密封圈的数量，提高了压下油缸工作的可靠性。
- ▲ 加强的锥筒卷制：在上下工作辊的可开合轴承座侧设有锥筒小口减速装置。由电控系统设置上工作辊倾斜两并保持上辊相对平衡，可在该卷板上实现其它机器上无法实现的小直径，大锥角锥体的卷制。
- ▲ 液压预卸压系统：通过独特的液压系统设计和工作压力检测，结合电控系统设计，可实现设备在高压下平缓的卸载，避免了工件的弹跳移动和液压系统产生的“水锤”现象对管路的冲击。
- ▲ 友好的人机界面：液压系统及各油缸的工作压力，电机工作状态，位移传感器的位移均以仪表控件的形式集中在显示屏显示。显示内容还包括各液压阀的失电状况，各软硬限位提示，设备过载报警，油温报警与冷却提示。

· This machine is particularly suitable for heavy plate for the production of cylinders and varying radiused parts.

· The 3 rolls plate bending machine (move horizontally) are manufactured with capacity of rolling 30mm thickness and 3metres length steel plate, and has been designed to achieve the best solutions in the metal forming industry.

· A hydraulic operated drop end bearing for the removal of completed cylinders, the machine has the capacity to produce high quality rolled parts and as a result of its low competitive cost is the preferred machine of the general fabricator, who needs the assurance of a strong and user friendly machine. General fabricators are the most users of the products.

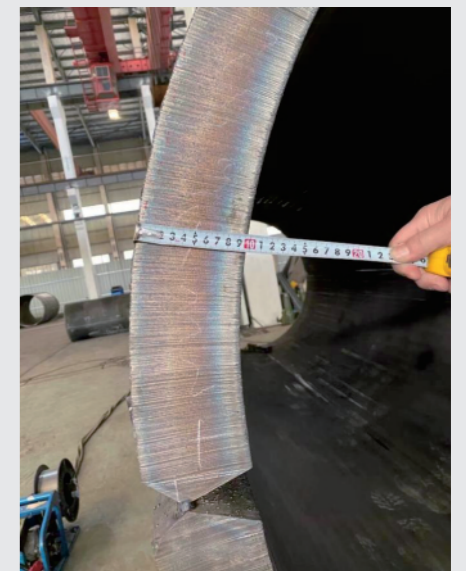

EZHONG

双驱动重型三辊卷板机

该机结构采用油缸一上一下，下辊水平移动通过电机传动，主传动采用鄂重专利节能双电机驱动专利技术，具有板材端部的预弯功能，结构可靠、性能优越、操作方便，该机的控制方式为NC控制，上辊升降采用位移传感器检测，LED显示可直接观察上辊工作位移，具有操作简单、方便、效率高等优点。

The structure of the machine adopts the oil cylinder up and down, the horizontal movement of the lower roll is driven by the motor, and the main drive adopts the patented energy-saving double motor drive technology of EZHONG. It has the pre bending function at the end of the plate, with reliable structure, superior performance and convenient operation. The control mode of the machine is NC control, the lifting of the upper roll is detected by the displacement sensor, and the LED display can directly observe the working displacement of the upper roll, It has the advantages of simple operation, convenience and high efficiency.



这是目前全球最大双驱动卷板机减速机，单重35吨。

This is currently the world's largest double drive plate rolling machine reducer, single weight 35 tons.



EZW11S-200x4000重型卷板机 EZW11S-200 x 4000 heavy duty plate rolling machine

主要用途重型压力容器、厚壁小管径工件。 It is mainly used for heavy pressure vessels and thick wall small diameter workpieces.

应用

风塔导管架

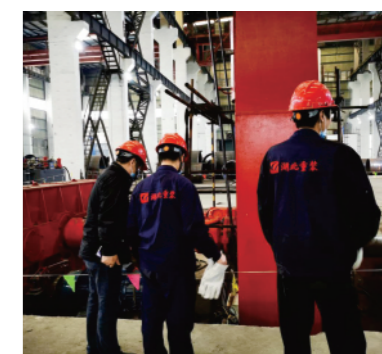
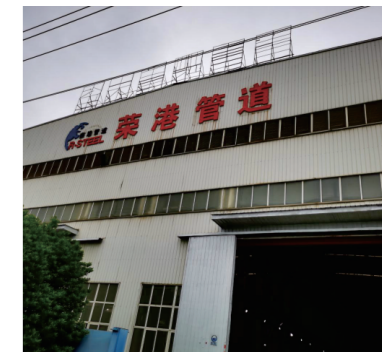

关于热卷

冷卷筒节不需热处理的条件为:对碳钢及16MnR, $S \leq 0.03Dg$ (Dg 为公称直径);对低轧辊钢(16MnR除外) $S \leq 0.03Dg$, 即规定的变形度为2.5%和3%, 大于此值需热处理。最大临界变形度5%, 否则在后续热加工中再结晶晶粒长大, 而降低钢材机械性能。上辊传动侧轴承座设热传感器, 上辊轴承能在摄氏300度下工作, 下辊轴承能在摄氏200度下工作, 热卷可以连续卷制筒体。

我公司在工作辊选材, 轴承选用, 防热辐射, 热传导, 工作辊长度变化, 液压油冷却等方面都有成熟的设计和丰富经验, 用户应提供卷板机或加热炉在车间的平面布置图(方位示意图), 以便我公司进行设计。

鄂重卷板机能够连续热弯、热卷、热校圆操作, 热卷温度范围: 卷圆850°C-1050°C, 应防止过热或过烧, 具体温度与含碳量有关;

For hot coils, no heat treatment is required for cold coil sections: for Carbon Steel and 16MnR, $s \leq 0.03DG$ (with the exception of 16MnR) and for low roll steel (with the exception of 16MnR), $s \leq 0.03Dg$, that is, the specified deformations are 2.5% and 3%, above which heat treatment is required. The maximum critical deformation is 5%, otherwise the re crystallization grain will grow in the subsequent hot working, and the mechanical properties of the steel will be reduced. The upper roller drive side bearing seat is equipped with heat sensor, the upper roller bearing can work at 300 °C, the lower roller bearing can work at 200 °C, and the hot coil can be coiled continuously. My company in the work roll material selection, bearing selection, heat radiation, heat conduction, work roll length changes, hydraulic oil cooling and other aspects have mature design and experience, users should provide the plate bending machine or heating furnace in the workshop floor plan (Orientation Diagram), in order to design our company. The hot coil temperature range is 850 °C-1050 °C. it should be prevented from overheat or overheat. The specific temperature is related to the carbon content



风塔卷板机

扫视频,更直观



风塔卷板机

鄂重风塔专用数控变几何水平下调式三辊卷板机, 采用双油缸下置式结构。该机上工作辊为主驱动辊: 上辊由液压马达(一个马达)通过行星减速机驱动上辊回转, 两下辊分别通过液压马达行星减速机驱动下辊回转。上辊的升降采用液压缸实现, 升降位移由计算机控制, 自动调平, 屏幕显示, 同步精度 $\pm 0.2\text{mm}$; 两下辊水平位置单独可调, 水平移动采用液压传动, 中心距可以调整; 翻倒侧下辊轴承座上装有卷锥挡块, 使扇形板的小端减速, 实现一定范围的锥体卷制; 一般锥角 30° , 满载的50%。上辊的尾部装有平衡机构, 可以方便卸出卷制后的工件及筒体。机器设有固定式操作台和遥控按钮盒各一个, 方便工人使用。设有安全联锁装置, 使操作更加安全。该机操作简单、维修方便, 卷制精度高, 是一种先进实用的大型卷板设备。

CNC variable geometry three roll plate rolling machine adopts the structure of oil cylinder down. The upper work roll of the machine is the main driving roll: the upper roll is driven by the hydraulic motor (one motor) through the planetary reducer, and the two lower rolls are driven by the hydraulic motor planetary reducer respectively. The lifting of upper roller is realized by hydraulic cylinder, the lifting displacement is controlled by computer, automatic leveling, screen display and synchronous precision $\pm 0.2\text{mm}$; The horizontal position of the two lower rollers can be adjusted independently, the horizontal movement adopts hydraulic transmission, and the center distance can be adjusted; The rolling cone stop is installed on the bearing seat of the lower roll on the overturning side to slow down the small end of the sector plate and realize the cone rolling in a certain range; General cone angle 30° , 50% of full load. The tail part of the upper roll is equipped with a balance mechanism, which can easily unload the rolled workpiece and cylinder. The machine is equipped with a fixed console and a remote control button box, which is convenient for workers to use. It is equipped with safety interlock device to make the operation safer. The machine is simple to operate, easy to maintain, high rolling accuracy, is an advanced and practical large plate rolling equipment.



EZW11S-120×3200液压中心距可调三辊卷板机



EZW11S-150×3500液压中心距可调三辊卷板机



EZW11S-180×3500液压中心距可调三辊卷板机

鄂重风塔三辊卷板机的特色

1、如何保证卷板速度 How to ensure the speed

卷板材成型最关键是由卷板机来完成的，一台根据正确的设计标准生产建造的卷板机，仅需一个操作人员即可实现每20-30分钟完成一件风塔部件的理想生产量，其中包括点焊。在整个生产过程中，数控操作系统及CNC软件将支持操作人员的工作。

The key to the forming of the plate bending is done by the plate bending machine, a plate bending machine produced and built according to the correct design standards, only one operator is needed to achieve the ideal production rate of one wind tower component every 20-30 minutes, including spot welding. In the whole production process, CNC operating system and CNC software will support the work of the operator.



2、如何保证卷板精度 How to ensure the accuracy

卷制件的精度:The Precision of the rolled section

有瑕疵的卷筒数量Amount of Barrel/Reel defect

预弯后平直端的长度Length of Flat End after Prebending

锥角的连贯性Consistency of the cone Angle

EZHONG

3、如何保持可靠 HOW TO BE RELIABLE

风塔的生产流程从切割、卷制、焊接、喷漆到发货是持续不断的过程。好的卷板机每年生产200台完整的风塔，这样可以用一台卷板机每天进行2-3次的倒班生产，这种情况下，机床的可靠性是保证整个生产线不停工的关键点。

The Wind Tower's production process from cutting, rolling, welding, painting to shipping is a continuous process. A good bending machine produces 200 complete wind towers every year, so a bending machine can be used for 2-3 shifts every day. In this case, the reliability of the machine is the key point to ensure that the whole production line is not stopped.

4、提高生产力的选选项包括 Options for increasing productivity

上支撑 Vertical Supports ;上支撑无需机床再另配任何高架起重设备，上支撑可以根据锥角进行自动倾斜。上支撑承载力在5-70吨之间。

侧支撑 Lateral Supports ;卷制薄板材的较大直径时需要侧支撑。上支撑与液压夹具相结合时，可以对板才进行自动校正，并便于点焊。

板材送料系统Plate Feeding System ;先进的送料台可自动调校板材，无需使用高架起重机来调整板材。在卷制时，送料台可以自动将板材调整在正确的位置上，并立即送进辊中卷制，因此节省时间创造价值。



5、纠偏装置DEFLECTOR

进料侧侧支撑设有筒体纠错装置，可纠正筒体的轴向及径向错位(管节错位顶正装置)，并且增加抓手对可抓住板材两侧前后伸缩，方便板材快速对齐。

The side support of the feeding side is provided with a cylinder body error-correcting device, which can correct the axial and radial dislocation of the cylinder body (the positive device of the dislocation top of the pipe joint)



6、数控系统 Numeric Control Units

现代的图形CNC被用于控制设备自动运转，PGS数控系统可以引导操作员进行编程，所以无需卷板机操作专家或信息技术专家。

A Modern Graphic CNC can be used to manage in the automatic cycle all machine functions. There is no need of expert bending roll operators nor experts in information technology as the PGS type of controls guide the operator trough the programming routines.

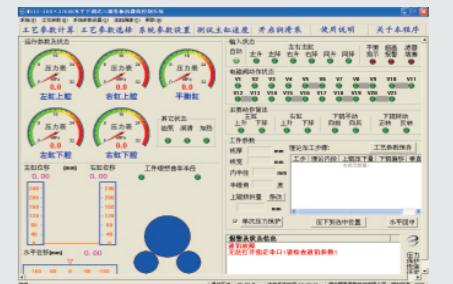

应用



EZW11S-140×4000风塔专用卷板机

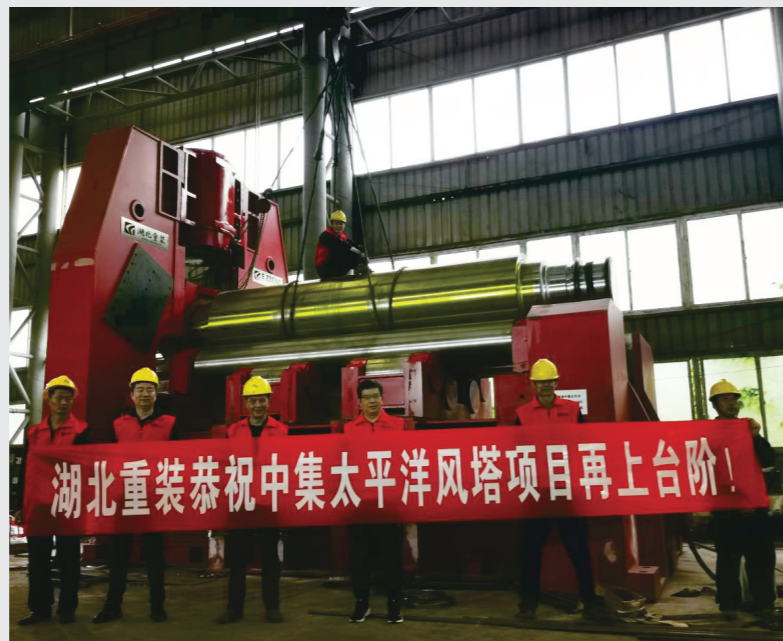

湖北重装恭祝中集太平洋风塔项目再上台阶!



W11s-2200T×18m

船用卷板机

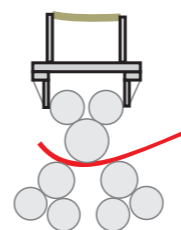

滚弯外板
Roll-bending outer strake

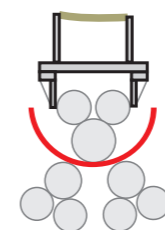

下辊中心距可调整，以适应不同的弯曲半径滚弯半圆（如起重柱等）
The bottom roll center distance is adjustable

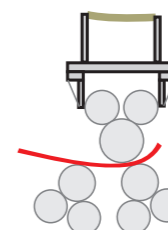

（为使末端平直部分最小）
偏心滚弯
Eccentric rolling circle

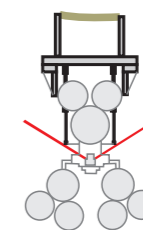

90°折弯
90°bending

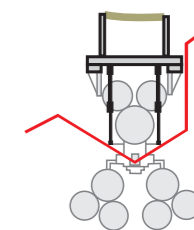

槽型舱折边（模具）
Grooved hatch flange (hem)

性能特点

鄂重生产的船用三辊卷板机引进吸收英国“smith”技术，具备卷板和折弯两用功能，主要弯制船舶舭部等圆弧板和压制槽型舱口；对舰部机舱部弯曲外板弯制加工。

分辊驱动：两下辊分别采用两电机或两液压马达经减速机减速独立驱动，解决机械干涉问题，提高工作辊寿命和工件外表面质量。

挠曲补偿：在上梁和上支承辊之间、下梁和下支承辊之间有支承辊联动装置，补偿上下梁挠曲变形；联动装置由柱塞缸驱动，各支承处的补偿量根据变形特性曲线设定，保证了在不同板厚和板宽的情况下加工工件的良好直线度。

变中心距：采用两下辊中心距可变技术，以适应更广的卷板范围和达到更高的卷板精度。

水平移动：下辊座及每组支承辊座都与同规格水平移动减速机连接，各水平移动减速机之间通过万向节相连，以保持运动同步。水平移动采用机械式即可解决多油缸同步的问题，又具有机械传动自锁性好的优点。

控制系统：本系统具有卷板和折弯两种操作方式，可方便转换。具有抗干扰能力强、能适应恶劣工业环境，并留有足够的扩展容量等特点。

CAPABILITY

· 3 ROLL SHIPPING PLATE BENDING MACHINE has the functions of both plate rolling and bending, especially used for bending arc sheer strake of bilge and pressing the grooved hatch, also processing the arc outer strake around the stern and engine room.

· Individual Roll Driven: Two bottom rollers are driven by the individually reducers, which avoid the mechanical interference, extends the service life of the working rolls and improves the out-surface quality of work piece.

· Flexing Compensation: There is an adjustable back-up roll device between the upper beam and upper back-up rollers, or the bottom beam and the bottom back-up rollers, which function is to compensate the rolling deformation. This device is driven by the plunger type cylinder. The load of compensation is set by the deformation performance curve, which guarantees high straightness of the work piece while processing the plates in different thickness and width.

· Mutable Center Distance: Adopting the technique of mutable center distance between the two bottom rollers, the aim is reaching the wider range and higher precision for rolling plates.

· Horizontal Moving: Bottom roll seat and each group of back-up roll seats are connected with the horizontal-moving reducers in the same specification, and the horizontal moving reducers join together through the universal joint as to move synchronously. Adopting mechanical moving one way makes the oil cylinders be synchronous, the other way owns the advantage of excellent self-locking performance.

· Control System: The system can work in both rolling and bending, and the two ways convert to each other conveniently. This system has features of powerful anti-interference ability, adaption to the severe industrial environment and sufficient extending capacity etc.

EZW11S			
Model	Full-load Min radius	Rows of back-up roller	Main motor power
3R-2200T×21000	R650mm	8	75KW×2
3R-2200T×18000	R650mm	8	75KW×2
3R-2000T×17000	R650mm	6	75KW×2
3R-1500T×13500	R600mm	4 (7)	55KW×2
3R-1000T×12500	R600mm	4 (6)	30KW×2

EZHONG has the right to revise the product feature ,figuration,specification and information without advance notice

鄂重机器技术参数可能有改变，解释权在鄂重。

F

扫视频,更直观



薄板四辊卷板机

扫视频,更直观



厚板四辊卷板机

Four Roll Plate Rolling Machine 四辊卷板机

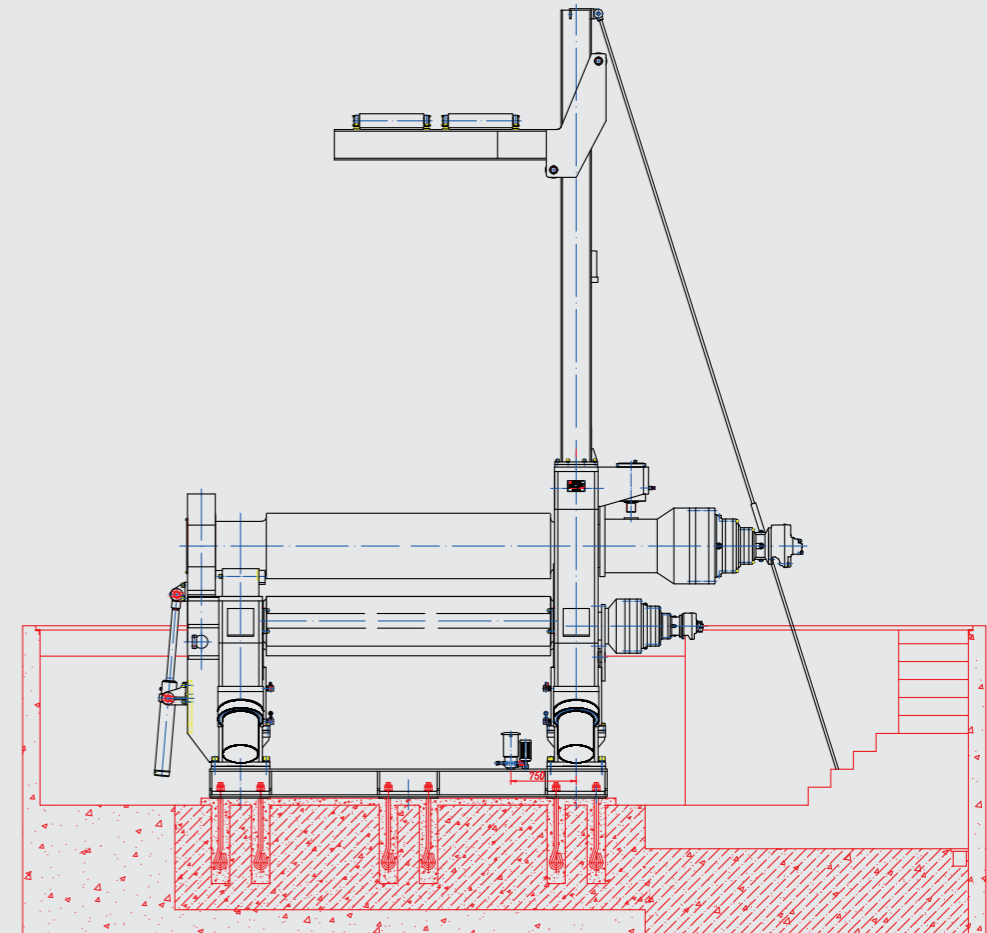

全液压薄板四辊卷板机

性能特点

- 很适合于薄板或者是铝板与不锈钢板
- 卷制整个筒体或者不同半径的部分筒体都能轻松实现
- 夹送辊以及侧辊都由液压活塞推动其移动
- 过载保护 - 三组数字输出形象显示工作辊位置
- 液压倒头架便于卷制完成的筒体的卸料
- 独立移动控制台便于操作
- 焊接钢机架并且整体消除应力
- 所有的工作辊由优质钢锻造经过热处理并感应式硬化处理
- 卷板机卷锥装置
- 液压平衡系统 - 双速工作系统
- 按照EC安全标准指导制造并且拥有CE认证
- 所有电气与液压部件均采用著名品牌

Performance characteristics

Very suitable for medium plate or aluminum plate and stainless steel plate

- The whole cylinder or parts of different radii can be rolled easily
- both pinch roll and side roll are driven by hydraulic piston
- overload protection · - three groups of digital output to display the position of work roll
- the hydraulic inverted head frame is convenient for the unloading of the rolled cylinder
- independent mobile console for easy operation
- welding steel frame and overall stress relief
- all work rolls are forged with high quality steel, heat treated and induction hardened
- coiling cone device of coiler
- hydraulic balance system · - two speed working system
- manufacture according to EC safety standards and CE certification
- all electrical and hydraulic components are of famous brands



挖机挖斗变曲率的卷制

EZW12X						
MODEL 型号	Useful Length 卷板宽度 mm	Without Prebending 无预弯 mm	With Prebending 预弯 mm	Motor Power 电机功率 KW	Working Speed 卷板速度 m/min.	Dimensions 外形尺寸 mm
EZW12X-16 × 2000	2000	16	12	22	1.5-6	5800 × 2000 × 1800
EZW12X-16 × 2500	2500	16	12	30	1.5-6	6810 × 2000 × 1870
EZW12X-20 × 2000	2000	20	16	30	1.5-6	6000 × 2000 × 1850
EZW12X-20 × 2500	2500	20	16	37	1.5-6	6850 × 2000 × 2070
EZW12X-20 × 3000	3000	20	16	45	1.5-6	7310 × 2100 × 2200
EZW12X-25 × 2000	2000	25	22	37	1.5-6	6300 × 2300 × 2070
EZW12X-25 × 2500	2500	25	22	45	1.5-6	6000 × 2600 × 2100
EZW12X-25 × 3000	3000	25	22	55	1.5-6	9000 × 3200 × 2500
EZW12X-25 × 4000	4000	25	22	63	1.5-6	10100 × 3600 × 2900
EZW12X-30 × 2000	2000	30	25	45	1.5-6	7500 × 2600 × 2500
EZW12X-30 × 2500	2500	30	25	55	1.5-6	8400 × 2500 × 2600
EZW12X-30 × 3000	3000	30	25	60	1.5-6	9200 × 2500 × 2900
EZW12X-30 × 4000	4000	30	25	60	1.5-6	10200 × 3500 × 2900
EZW12X-40 × 2000	2000	40	36	45	1.5-6	8200 × 3000 × 2600
EZW12X-40 × 2500	2500	40	36	60	1.5-6	8700 × 3500 × 2900
EZW12X-40 × 3000	3000	40	36	76	1.5-6	8200 × 3600 × 3000
EZW12X-40 × 4000	4000	40	36	80	1.5-6	12500 × 4000 × 3500
EZW12X-50 × 2000	2000	50	45	60	1.5-6	8500 × 3500 × 3000
EZW12X-50 × 2500	2500	50	45	75	1.5-6	9000 × 4000 × 3300
EZW12X-50 × 3000	3000	50	45	90	1.5-6	9800 × 4300 × 3500
EZW12X-60 × 2500	2500	60	50	90	1.5-6	9500 × 4500 × 3700
EZW12X-60 × 3000	3000	60	50	121	1.5-6	10000 × 4500 × 3800

EZHONG has the right to revise the product feature ,figuration,specification and information without advance notice
鄂重机器技术参数可能有改变,解释权在鄂重。

全液压重型四辊卷板机

性能特点

- 很适合于中厚板的卷制
- 卷制整个筒体或者不同半径的部分筒体都能轻松实现
- 夹送辊以及侧辊都由液压活塞推动其移动
- 过载保护 - 三组数字输出形象显示工作辊位置
- 液压倒头架便于卷制完成的筒体的卸料
- 独立移动控制台便于操作
- 焊接钢机架并且整体消除应力
- 所有的工作辊由优质钢锻造经过热处理并感应式硬化处理
- 卷板机卷锥装置
- 液压平衡系统 - 双速工作系统
- 按照EC安全标准指导制造并且拥有CE认证
- 所有电气与液压部件均采用著名品牌



EZW12-100×4000四辊卷板机

Performance characteristics

Very suitable for medium plate or aluminum plate and stainless steel plate

- The whole cylinder or parts of different radii can be rolled easily
- both pinch roll and side roll are driven by hydraulic piston
- overload protection · - three groups of digital output to display the position of work roll
- the hydraulic inverted head frame is convenient for the unloading of the rolled cylinder
- independent mobile console for easy operation
- welding steel frame and overall stress relief
- all work rolls are forged with high quality steel, heat treated and induction hardened
- coiling cone device of coiler
- hydraulic balance system · - two speed working system
- manufacture according to EC safety standards and CE certification
- all electrical and hydraulic components are of famous brands



Leveling Machine 板材校平机

扫视频,更直观



高强度薄板校平机

扫视频,更直观



高强度厚板校平机

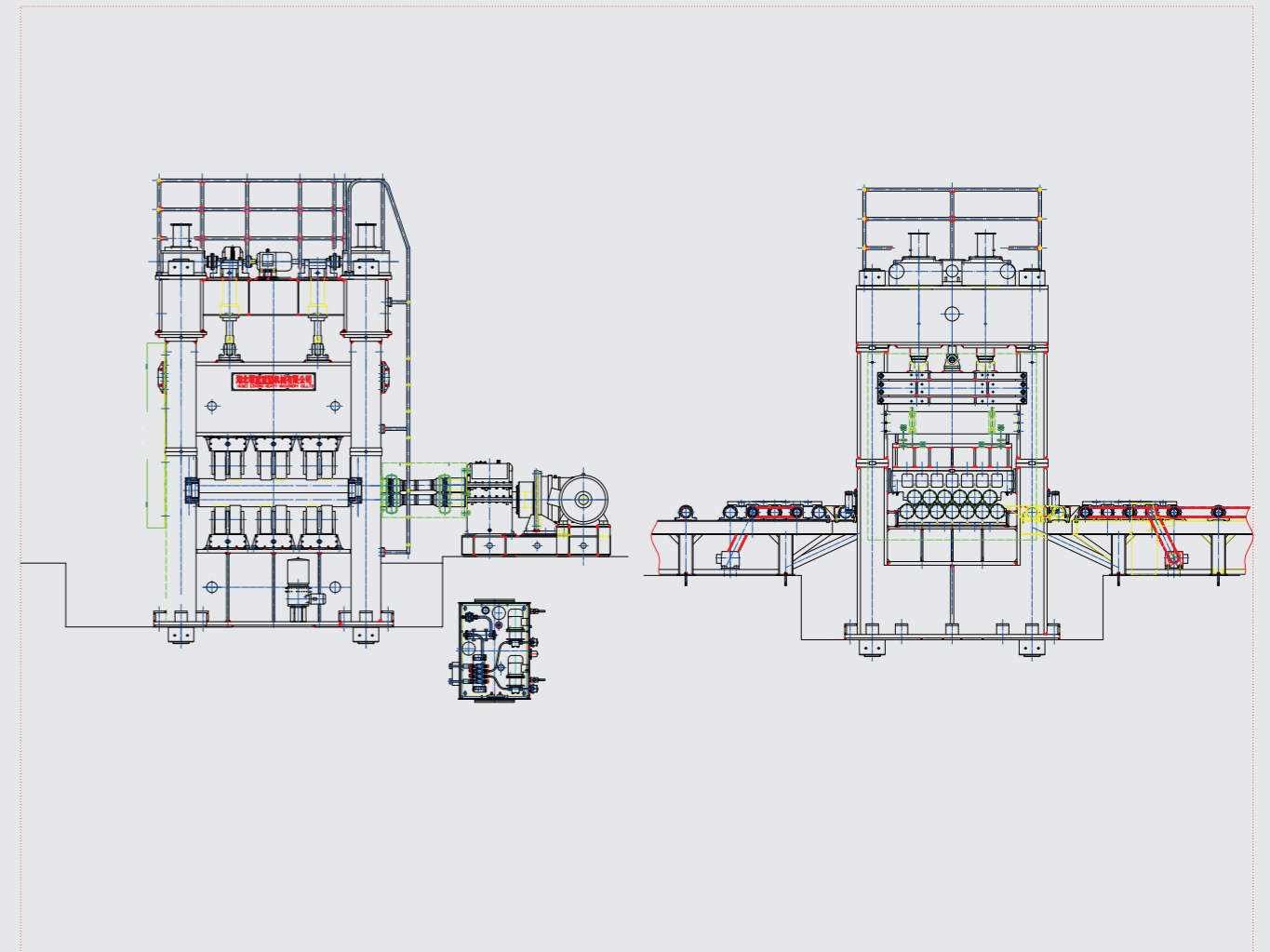



鄂重W43-60×2500九辊校平机在阿塞拜疆电力公司现场

鄂重校平机.行业技术引领

最优化合理的设计

经与华中科技大学、武汉理工大学合作,本矫平机运用大量先进制造技术,不仅首次全部采用模块化定义规范,开展SolidWorks全三维数字化设计、Cosmos设计验证、结构优化、应力、应变直观演示分析及模块化设计,还利用数据管理系统开展在线全关联设计,使得协调便捷快速。

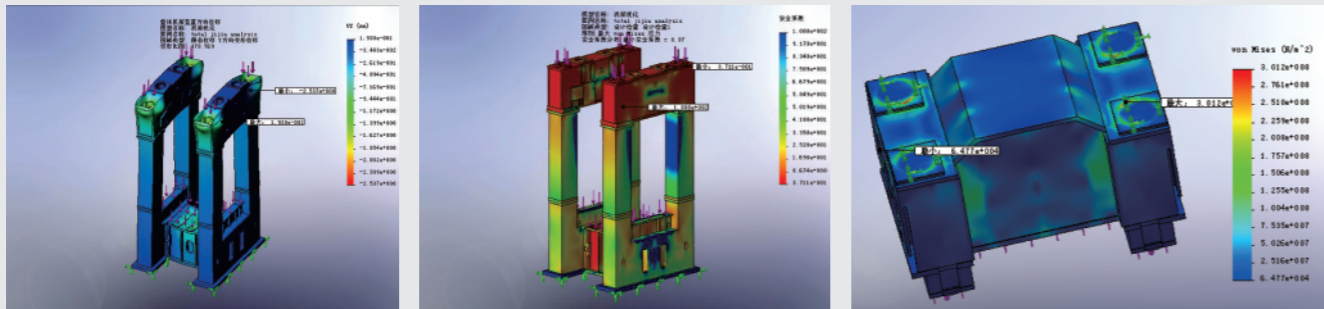

智能化

控制方式:PLC+触摸屏+按钮,所有工作参数在人机界面可设置,具有参数记忆、存储、断电记忆功能;本设备配备数据外接装置,确保在智能工厂运转中具备实时传输数据功能;

Intellectualization:PLC + touch screen + button, all working parameters can be set in man-machine interface, with parameter memory, storage, power-off memory function; The equipment is equipped with data external device to ensure the function of real-time data transmission in the operation of intelligent factory;

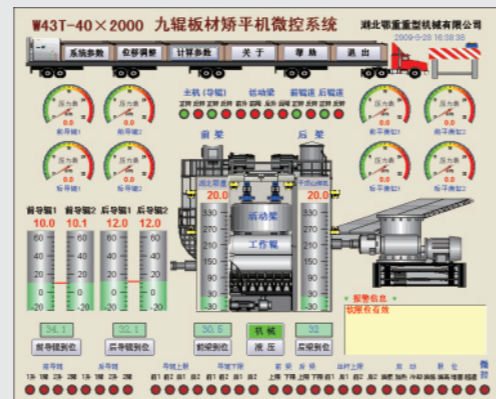

EZHONG

人机互联

该机控制系统具有存储、调用、编辑工艺及设备参数功能,具有误操作识别预警功能。使用时,在操作台上,可以根据板厚、板宽、材料强度等参数,或数据库已有参数,设定进、出口压下量,实现工作辊出、入口间隙等自动调整,并可手动调整和修正

Man machine interconnection

The control system has the functions of storing, calling, editing process and equipment parameters, and has the function of misoperation identification and early warning. When in use, on the operating table, according to the plate thickness, plate width, material strength and other parameters, or the existing parameters in the database, the inlet and outlet reduction can be set to realize the automatic adjustment of the inlet and outlet clearance of the work roll, and the manual adjustment and correction can be realized

校平机开口量自动调节装置 (专利号202023121026.1)

待校板材进入到校平机之前,通过对板材信息处理单位进行扫描测量出板材厚度、宽度、材质,信号传递到电器控制柜,通过PLC读取数据,自动进行开口量运算,调整机器开口量,经过修正后确认数值同时存储此修正数据组,待再次进料时程序会根据不同厚度对开口量进行自动调整,并按该数据组执行,实现自动调整进出口开口量;并在出料口留有数据接口,支持激光平面度检测功能。

Automatic adjustment device of leveling machine (Patent No. 202023121026.1)

Before the calibration plate enters the leveling machine, the thickness, width and material of the plate are measured by scanning the plate information processing unit, and the signal is transmitted to the electrical control cabinet. The data is read by PLC, the opening amount of the machine is automatically calculated, and the opening amount of the machine is adjusted. After correction, the value is confirmed, and the correction data group is stored at the same time, When feeding again, the program will automatically adjust the opening amount according to different thickness, and execute according to the data group to realize the automatic adjustment of the opening amount of import and export; The data interface is reserved at the discharge port to support the laser flatness detection function.

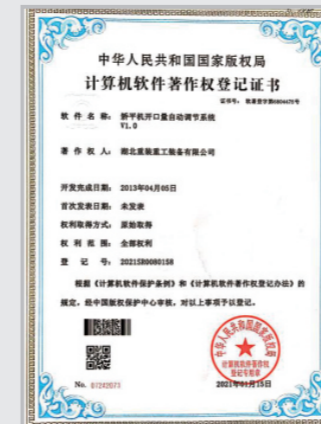

■ 厚板重型校平机

本机为辊列不平行式及边上辊可调,采用线性递减压下矫正方式,符合钢板矫正规律。

The machine is of non parallel roller row and adjustable upper roller. It adopts linear progressive pressure reduction and lower correction mode, which conforms to the steel plate correction law.



印度JSL官员到上海振华考察W43-80×3000七辊校平机



精度高、效率高

本机具有比普通校平机更多的压下方式,能平行和倾斜压下的功能,校平机可双向进料,进料端可以单独可调,解决了普通上辊系整体倾斜调整式校平机板料喂料困难的难题,减少了辅助上料时间,提高了工人的操作方便性板料变形更充分,校平精度更高,板料校平后应力均匀,盲区小。

High precision and high efficiency: the upper roll of this machine has more pressing ways than the ordinary leveler, and can be pressed parallel and inclined. The leveler can feed in two directions, and the feeding end can be adjusted separately, which solves the problem of difficult sheet feeding of the ordinary upper roll system overall tilt adjustment leveler, reduces the auxiliary feeding time, improves the operation convenience of workers, and makes the sheet deformation more sufficient. The results show that the leveling accuracy is higher, the stress is even and the blind area is small.



能耗低

该机具有变辊数校正功能,可根据不同板料板厚使用不同工作辊数,有利于降低能源消耗,延长机器使用寿命。

Low energy consumption: the machine has the correction function of variable roll number, which can use different work roll number according to different plate thickness, which is conducive to reducing energy consumption and prolonging the service life of the machine.



自动化程度高

本数控系统输入板厚、板宽、强度等参数,数控系统自动计算出压下量,完成校平压下工艺参数的调整,方便快速地对工件进行校平,大大提高了生产效率。

High degree of automation: the numerical control system inputs parameters such as plate thickness, plate width, strength, etc., the numerical control system automatically calculates the reduction, completes the adjustment of straightening and reduction process parameters, makes it convenient and fast to straighten the workpiece, and greatly improves the production efficiency.

应用



武汉海波钢构W43-32×3600七辊校平机,主要是桥梁钢结构的校平和消除内应力

金属复合板材校平机

金属复合板它不仅具有贵金属的耐磨性、耐腐蚀性，还有碳钢良好的可焊性、延伸性、成型性，它是在普碳钢基体上包覆一层不锈钢的双金属复合材料。它既具有碳钢良好的强度、深加工性能以及导热性，又具有不锈钢的耐磨、耐腐蚀等性能和装饰性，可大大降低成本。

鄂重复合板材校平机运用分辊驱动、边辊可调节等专利技术解决了在金属板材复合工艺过程中产生的板材应力集中，变形量大的行业难题。

Metal clad plate not only has wear resistance and corrosion resistance of precious metals, but also has good weldability, extensibility and formability of carbon steel. It not only has good strength, deep processing performance and thermal conductivity of carbon steel, but also has wear-resistant, corrosion-resistant and decorative performance of stainless steel, which can greatly reduce the cost.

With the patent technology of separating roller driving and side roller adjustable, the EZHONG heavy composite plate leveler solves the difficult problem of plate stress concentration and large deformation in the process of metal plate composite technology.

中船725所EZW43T-40×3000九辊金属复合板材校平机 360MPa 九辊高强度钢校平机

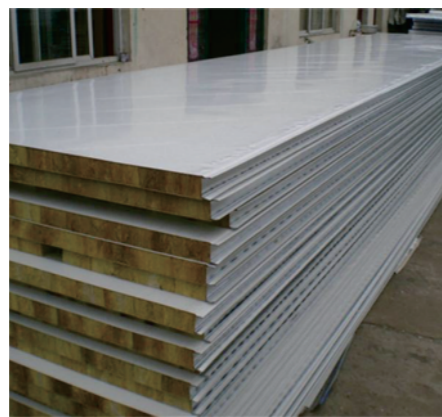

安徽金元公司EZW43T-40×3000九辊金属复合板材校平机

安徽中钢联EZW43T-30×4200九辊校平机

EZW43-辊式板材校平机 PLATE LEVELING MACHINE

Model 型号	Yield limit 屈服极限 /Mpa	Working roller 工作辊数量	Max. thickness 最大板厚 mm	Min. thickness 最小板厚 mm	Plate width 板材宽度 mm	Leveling accuracy 校平精度 mm/m ²	Support roller 支撑辊列数	Pressing stroke 压下行程 mm	Speed 校平速度 m/min	Main motor power 主电机功率 KW	Depress motor power 压下电机功率 KW
EZW43B-8×1500	1100	15	8	3	1500	1.0	3	+50~-17	6	45×2	3×2
EZW43BY-8×2000	1600	17	8	3	2000	1.0	3	+130~-15	3.2~6	75×2	4×2
EZW43B-10×1500	960	13	10	3	1500	1.0	3	+50~-15	3.2~8	75	3×2
EZW43B-10×1800	1600	15	10	3	1800	1.0	3	+130~-15	3.2~6	55×2	3×2
EZW43B-10×3000	360	13	10	3	3000	1.0	4	+50~-5	6.9	7.5×2+3.7×2	5.5×2
EZW43B-12×1000	960	11	12	4	1000	1.0	2	+50~-15	3~8	30×2	2.2×2
EZW43C-12×2000	1000	13	12	4	2000	1.0	4	+50~-25	4.5	55×2	4×2
EZW43B-12×3600	360	11	12	4	3600	1.0	4	+45~-15	6	30×2	4×2
EZW43C-16×2500	1100	11	16	4	2500	1.0	3	+60~-23	3~8	90×2	7.5×2
EZW43C-16×3200	360	11	16	4	3200	1.0	4	+50~-5	7.32	13×6	5.5×2
EZW43-20×2000	1500	9	20	4	2000	1.0~1.5	3	+70~-20	6	167	5.5×2
EZW43T-20×2000	600	9	20	4	2000	1.0~1.5	3	+70~-23	3~6	11×9	5.5×2
EZW43C-20×2000	940	11	20	4	2000	1.0	3	+60~-20	6.2	37×2	5.5×2
EZW43C-20×2500	360	13	20	5	2500	1.0~1.5	4	+60~-20	6	75×2	7.5×2
EZW43C-20×3200	245	11	20	5	3200	1.0~1.5	4	+60~-20	6	11×7+5.5×2	5.5×2
EZW43-25×1500	360	11	25	6	1500	1.0~1.5	3	+50~-5	6	30×2	2.2×2
EZW43T-25×2000	360	9	25	6	2000	1.0~1.5	3	+10~-20	0~9	7.5×7+4×2	4×2
EZW43-25×2500	1500	9	25	6	2500	1.0~1.5	4	+60~-20	6	11×7+5.5×2	5.5×2
EZW43-25×2450	1500	9	25	5	2450	1.0~1.5	4	+60~-20	6	11×7+5.5×2	5.5×2
EZW43TY-30×1500	360	11	30	7	1500	1.0	3	+60~-20	6	30×2	4×2
EZW43T-30×3000	360	9	30	6	3000	1.0~1.5	3	+70~-10	0~6	7.5×9	5.5×2
EZW43T-36×4500	360	9	36	10	4500	1.0	4	+30~-10	0~6	11×7+7.5×2	5.5×2
EZW43-40×2000	700	9	40	10	2000	1.0	3	+240~-40	0~6	22×7+11×2	5.5×2
EZW43-40×3000	345	9	40	10	3000	1.0~1.5	4	+300~-20	0~5	15×7+7.5×2	7.5×2
EZW43T-46×4500	345	7	46	12	4500	1.0~2.0	4	+90~-20	0~6	15×7+7.5×2	11×2
EZW43-50×3000	245	7	50	10	3000	1.0~2.0	4	+70~-5	6	26×2+17×3	4×2
EZW43T-60×2500	245	9	60	10	2500	1.0~1.5	3	+200~-25	5	15×7+5.5×2	5.5×2
EZW43T-80×3000	360	7	80	30	3000	1.0~1.5	3	+120~0	6	30×3+5.5×4	13×2
EZW43T-90×3000	360	7	90	30	3000	1.0~1.5	2	+300~-10	4.8	22×5+11×2	13×2
EZW43T-100×1500	345	7	100	25	1500	1.0~2.0	2	+200~0	4.5	11×7	7.5×2
EZW43T-120×3000	400	7	120	25	3000	1.0~2.0	3	+300~0	2.4~6	37×5+22×2	18.5×2

Model illustration 机器型号说明

Eg: EZW43T-120×3000 Plate Leveling Machine 辊式板材校平机		Ezhong can supply all specification according to customer's request as long as we have the following data. 鄂重按照客户的特定需求定制，请您提供以下数据。	
EZ	"Ezhong" brand	最大校平厚度 Max. Leveling Thickness	(……) such as "120mm"
W43	Plate Leveling Machine	最大校平宽度 Max. Leveling Width	(……) such as "3000mm"
120mm	Max. Leveling Thickness	校平精度 Leveling Accuracy	(……) such as "1.0~1.5 mm/m ² "
3000mm	Max. Leveling Width	屈服极限 Yield Limit	(……) such as "400MPa"

Ezhong has produced the largest bending machine, plate leveling machine and horizontal axle-pressing machine.
鄂重生产过世界上最大的卷板机、校平机和轮轴压装机。
Ezhong is the enterprise technology center and provincial postdoctoral industry base.
鄂重是湖北省级技术中心和博士后产业基地。

■ 高强钢工程机械校平机

本机型为辊列不平行式及边上辊可调。该机具有技术先进、操作简单方便、工艺范围广、数显显示结合工控机控制等特点，利用工作控制台可以完成所有进料、校平、出料等工作，并有记忆功能。

工作辊装置是本机的核心部件，板材通过多根工作辊，对板材进行多次反复弯曲，使多种原始曲率逐步变为单一曲率，并最终被校平。该机装备有两个边上辊，兼顾了薄板厚板的不平行式校平，扩大校平工件的范围。

压下机构使用了两套独立的动力系统，两台电机同时转动时，实现活动横梁的升降，电机分别转动时，实现活动横梁的摆动。

传动装置使用了分辊主驱动技术，多台电机运转带动多个工作辊的转动。进出料轨道由本机控制台控制，电动可逆行，并确保两者具有相同的运动速度。

This machine is of non parallel roller row and adjustable side roller. The machine has the characteristics of advanced technology, simple and convenient operation, wide range of technology, digital display combined with industrial computer control, etc.

As shown in Figure 1, the work roll device is the core part of the machine. The plate is repeatedly bent through multiple work rolls, so that a variety of original curvature gradually becomes a single curvature, and is finally leveled. The machine is equipped with two side rollers, which can take into account the uneven leveling of thin and thick plates and expand the range of leveling work pieces.

The screw down mechanism uses two independent power systems. When the two motors rotate at the same time, the lifting of the movable beam is realized. When the motors rotate respectively, the swing of the movable beam is realized.

The driving device uses the main driving technology of separate roll, and multiple motors drive the rotation of multiple work rolls. The feeding and discharging track is controlled by the console of the machine, and the electric drive can be reversed to ensure that both have the same movement speed



EZW43-20×1500 785MPa 11辊高强钢校平机 三一重工

EZHONG

应用



■ 高强钢薄板校平机

性能特点

- ◎ 该机型主要应用于工程机械作业690MPa、785MPa、960MPa、1100MPa、等薄板的校平与整形。
- ◎ 主传动系统上下辊为全主驱动，有两台电机带动，可急停制动，具有软启动装置，对电网冲击小，性能可靠，噪音低，结构紧凑。
- ◎ 上下支承辊为多列倍径支承，与工作辊排列为上下布棋式，底部设整体式斜铁调整机构，手动微调方式调整上下矫平辊辊形，保持工作辊刚度，矫平薄板波浪弯、凹凸瓢曲变形时，需要用支承辊来改变工作辊的凸度，手动调整上矫平辊开口量和倾斜角，可方便地适应波浪弯曲、瓢形板材等矫正要求。
- ◎ 工作辊轴颈全部采用轧机专用的调心滚针轴承，与铜套相比传动效率高、使用寿命长，工作辊摩擦阻力小，不打滑条件大大改善，可以矫更薄的钢板；
- ◎ 采用闭式机架，矫正力内部封闭，机架外观简洁，整体刚性好，不下地基也能满载矫平；
- ◎ 压下转角机构和转角机构是合成一起的，采用成组技术，使用了两套相同的动力系统，采用YEJ型电机驱动，使活动横梁能准确自动定位和快速摆角；
- ◎ 在活动横梁设较大的抬升高度，方便机器换辊维修；
- ◎ 采用电动双线给油器集中润滑，通过电动双线给油器、干油管路对工作辊、支承辊轴承、蜗轮箱、螺杆等润滑点进行单独润滑；
- ◎ 测量和电控系统先进，设备采用德国西门子PLC S7控制。在操作台上，可根据板厚、板宽、材质及原始曲率等参数，设定进、出口压下量。PLC具有编辑、存储记忆工艺参数功能，可以随时调用和修正；
- ◎ 保护功能齐全压下传动轴等外露旋转体安装有防护罩，进料口有光电开关保护。



EZW43-10×1500 1100MPa 13辊高强钢校平机 三一重工新材料

The main features are as follows

The upper and lower rollers of the main drive system are all main driven, driven by two motors, which can stop and brake in an emergency. It has a soft start device, which has small impact on the power grid, reliable performance, low noise and compact structure.

The upper and lower backup rolls are multi row double diameter supports, which are arranged in a checkerboard pattern with the work rolls. An integral inclined iron adjusting mechanism is set at the bottom. The roll shape of the upper and lower leveling rolls can be adjusted by manual fine adjustment to maintain the rigidity of the work rolls. When straightening the sheet with wave bending and convex concave deformation, the crown of the work rolls needs to be changed by backup rolls, and the opening amount and inclination angle of the upper leveling rolls need to be manually adjusted, It can be easily adapted to the correction requirements of wave bending and ladle plate.

Compared with the copper sleeve, the work roll has high transmission efficiency, long service life, low friction resistance and no slip condition, which can straighten thinner steel plate;

The closed frame is adopted, the internal rectification force is closed, the appearance of the frame is simple, the overall rigidity is good, and the full load leveling can be carried out without foundation;

The press down angle mechanism and the angle mechanism are combined together, using group technology, using two sets of the same power system, using YEJ motor drive, so that the movable beam can accurately and automatically position and quickly swing angle;

A large lifting height is set on the movable crossbeam to facilitate the maintenance of machine roll changing;

The electric double line oil feeder is used for centralized lubrication, and the working roll, backup roll bearing, worm gear box, screw and other lubrication points are separately lubricated through the electric double line oil feeder and dry oil pipeline;

The measurement and electric control system is advanced, and the equipment is controlled by Siemens PLC S7. On the operating table, the screw down at the inlet and outlet can be set according to the plate thickness, plate width, material and original curvature. PLC has the function of editing, storing and memorizing process parameters, which can be called and modified at any time;

The protection function is complete, the exposed rotating body such as the drive shaft is installed with a protective cover, and the feed port is protected by a photoelectric switch



为中联重科设计制造的EZW43-8×1500 高强钢800MPa 13辊校平机

应用



长沙瑞捷EZW43T-25×2000 1200MPa 11辊高强度钢校平机

■ 高强防弹钢板校平机

该机EZW43CY-12×2200 1100MPa高强度钢校平机应用于宝钢钢铁公司,主要生产防弹钢板的校平,主传动结构运用了“分组主驱动”技术的原理工作,采用同轴双驱动形式(专利号ZL 2016 2 1330433.4)及倍径复合支承销专利技术(专利号ZL 2016 2 1332160.7),由四台行星减速机通过齿式联轴器与减速机(分配箱)(传动比*i*=1)连接,在工作辊两端同时驱动17根工作辊,使万向接轴传动扭矩减半,提高万向接轴的安全系数。

The EZW43cy-12 × 2200 1100MPa 17 roll high strength steel leveling machine is used in WISCO. It mainly produces the leveling of bulletproof steel plate. The main transmission structure uses the principle of "group main drive" technology, and adopts the coaxial double drive mode. Four planetary reducers are connected with the reducer (distribution box) (transmission ratio *i* = 1) through the gear coupling, 17 work rolls are driven at both ends of the work roll at the same time to reduce the transmission torque of the universal joint shaft by half and improve the safety factor of the universal joint shaft.



P

press
压力机

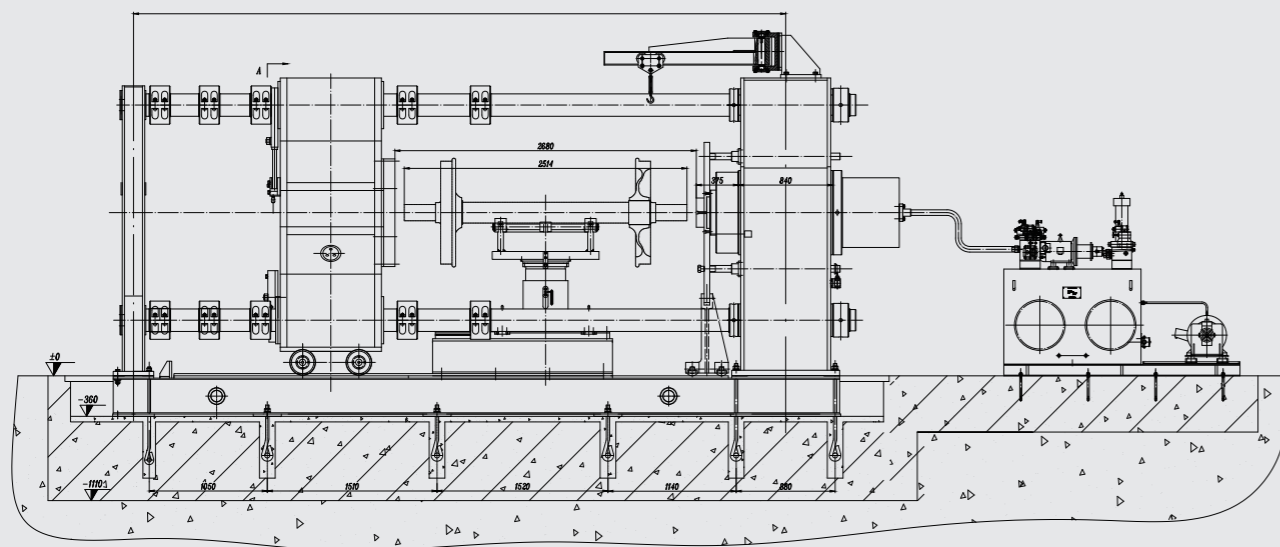

■ 卧式轮轴压装机

本机器适用于冶金、矿山机修；机器制造及大型电机制造行业，主要用于大型轴类零件的压装及拆卸工作。

This machine is suitable for metallurgy, mine machine repair, machine manufacturing and large motor manufacturing, mainly used for large shaft parts of the pressure assembly and disassembly work.

EZY92	HORIZONTAL AXLE PRESS MACHINE						
Model 型号	Nominal pressure 公称压力 KN	Max.Stroke 最大行程 mm	Max gear/ axle diameter 最大嵌入轮/ 轴直径 mm	Max.inlay length 最大嵌入长度 mm	Pressing speed 压装速度 mm/s	Main motor power 主电机功率 KW	Dimension 外形尺寸 mm
EZY92-2500KN (Standard)标准型	2500	700	1300/300	3500	0~4	18.5	6180x 1280x 2420
EZY92-3150KN (Standard)标准型	3150	600	1300/350	2200	0~4	18.5	5360 x 1200 x 2400
EZY92-3150KN (Long)加长型	3150	700	1850/600	3500	0~4	18.5	6940 x 1600 x 2560
EZY92-5000KN (Standard)标准型	5000	700	1850/350	3500	0~2	18.5	6990x 1700 x 3000
EZY92-5000KN (Long)加长型	5000	700	1850/450	5000	0~2.5	18.5	8300 x 1800 x 3000
EZY92-6300KN (With travelling crane)	6300	800	2000/860	5000	0~2	20	8900x 1880x 2800
EZY92-8000KN	8000	800	2200/860	6500	0~2	22	9600 x 2800 x 3100
EZY92-10000KN	10000	1200	5000/800	7000	0~2	22	12800 x 5900 x 3700

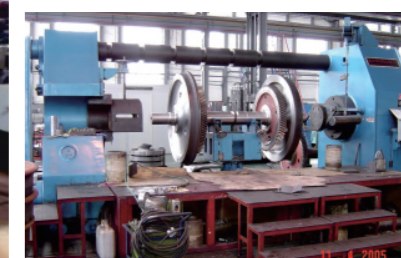
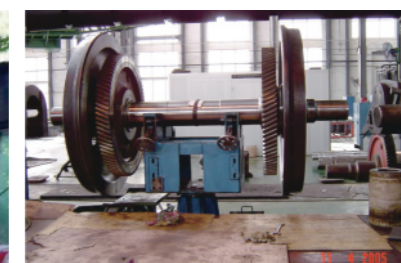

机床的结构及功能

机床的组成:本机前固定梁、活动梁、后支架、底盘、液压系统、小车装置、电气系统主要部分组成。

Machine tool structure and function

machine tool composition: the machine front fixed beam, movable beam, after the support, chassis, hydraulic system, car device, electrical system is composed of the main parts.

安全保护装置

- 01 当系统超压时,具有压力继电器停机保护和溢流保护。
- 02 固定梁和控制台两处各安装一个紧急停止按钮。
- 03 机械电气设备控制安全系统符合中国国家标准或相应标准,安全连锁系统可靠。
- 04 油冷却采用空气冷却,当油温达到60°C时,设备自动报警停机。

Safety protection:

when the system overvoltage, with pressure relay shutdown protection and overflow protection.

install an emergency stop button at each of the fixed beam and console locations.

The safety system of mechanical and electrical equipment and control conforms to the national standards of China or corresponding standards, and the safety interlock system is reliable.

The oil is cooled by air. When the oil temperature reaches 60 °C, the equipment will automatically alarm and stop.

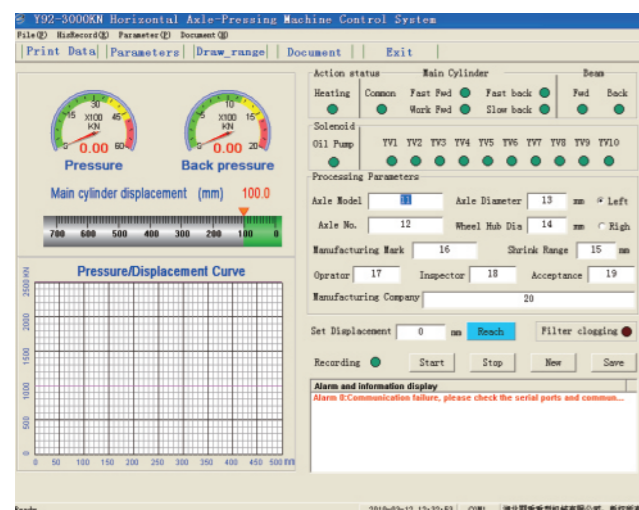

单臂油压机

液压机的用途和特点

本机器适用于各种可塑性材料的压制矫正、折边及冲压等工艺。

本机器具有独立的动力机构及电气系统,并采用按钮集中控制,工艺动作采用PLC控制,可实现点动、半自动两种操作方式。

Application and characteristics of hydraulic press

This machine is suitable for various plastic materials pressing correction, folding and stamping process.

The machine has independent power mechanism and electrical system, and adopts button centralized control, process action is controlled by PLC, which can realize two operation modes of inching and semi-automatic.



500T单臂压力机-河南中昊



200吨单臂压力机 河南中昊



机器性能及结构概述

液压机采用单柱分体式结构,采用优质钢板焊接平整无残次。机身由工作台、支座、上横梁通过五根拉杆组成一C型刚性框架;

滑块与油缸活塞杆相连接。以四根导柱为导向作上下移动,导向柱的外表面淬火后镀铬,精度高,刚性好。

压力实现:主缸为一只活塞缸。缸体安装在上横梁上,活塞杆通过连接法兰与滑块相连接。缸体材料为优质锻钢,保证材质均匀;活塞杆表面中频淬火处理。主缸密封件采用进口材料密封圈,确保密封可靠。

工作台、滑块开有“T”型槽,便于用户模具安装和固定。

Overview of machine performance and structure

The hydraulic press adopts single column split structure, adopts high-quality steel plate, and is welded flat without defects. The fuselage is composed of worktable, support and upper crossbeam, and a C-type rigid frame is formed by five pull rods;

The sliding block is connected with the cylinder piston rod. Four guide pillars are used as guide to move up and down. The outer surface of the guide pillar is chrome plated after quenching, with high precision and good rigidity.

Pressure realization: the master cylinder is a piston cylinder. The cylinder block is installed on the upper crossbeam, and the piston rod is connected with the sliding block through the connecting flange. The cylinder block is made of high-quality forged steel to ensure uniform material; The surface of piston rod is treated by medium frequency quenching. The seal of master cylinder is made of imported material to ensure reliable sealing.

The working table and slide block are provided with a T-shaped groove, which is convenient for users to install and fix the mould.



江苏荣港6000T压力机



P

Profile Bending Machine 型材弯曲机

性能与特点

型材弯曲机,是用于角钢、槽钢、工字钢、扁钢、方管、圆管等各种异型材的卷弯专用高效加工设备,可完成各种型材的端部预弯,卷制圆形、弧形工件,广泛用于航空航天、石油化工、水电、造船、汽车制造、机械制造、钢结构建筑等行业。型材弯曲机结构概述该机为弧线下调式结构,上辊轴固定,两下辊轴围绕一中轴相对于上辊轴分别作弧线升降运动,其功能主要是预弯型材的端部和使型材弯曲变形,同时两下辊轴也为主传动轴,由液压马达驱动,使弯曲变形的型材卷制成形。为防止型材在卷弯过程中的扭曲变形,提高型材的卷弯精度,增设有两托辊和滚轮,可上、下垂直移动,以适应卷弯不同规格和不同弯曲半径的型材。

180-型材弯曲机为弧线下调式三辊型弯机,床身为钢板结构件,做消除内应力处理,主辊的传动通过液压系统经液压马达、齿轮、链轮传递给动力做旋转运动。两只边辊,绕中轴做弧线式运动,通过液压系统经液压马达、齿轮传递的动力与主辊同时做旋转运动,托辊则安装在边辊上,使托辊随边辊同时做弧线运动,以确保卷制型材的精度。根据现场和型材的要求,可以立式或卧式安装。

公司年产的型材弯曲机是一种专用卷弯角钢、槽钢、工字钢、扁钢、方管、圆钢等各种异型材的高效加工设备,可一次上料完成卷圆、校圆工序,广泛用在石油、化工、水电、造船及机械制造等行业。本机结构先进,工作可靠,体积小,功能齐全,是目前国内外先进的型材成型设备。



	THW24-16	THW24-45	THW24S-75	THW24S-100	THW24-140	THW24-180	THW24-320	THW24-400	THW24-500
角钢外弯	80×10 φ800	100×12 φ1000	120×12 φ1250	150×16 φ1000	160×20 φ1600	200×20 φ3000	200×28 φ2000	200×281) φ1800	200×281) φ1800
角钢内弯	80×10 φ1000	100×10 φ1000	100×12 φ1250	130×15 φ1200	150×20 φ1600	180×16 φ3000	200×20 φ2000	200×281) φ2000	200×281) φ2000
T型钢外弯	80×9 φ700	100×12 φ800	120×13 φ1250	150×15 φ1200	160×20 φ1400	200×20 φ1600	200×28 φ1800	200×281) φ1600	200×281) φ1600
T型钢内弯	80×9 φ1300	100×12 φ1500	100×12 φ1500	130×15 φ1700	150×20 φ2000	180×18 φ2500	200×20 φ2800	200×281) φ2500	200×281) φ2500
扁钢立弯	80×18 φ800	100×25 φ700	120×25 φ1000	150×30 φ1000	175×40 φ1200	200×50 φ2000	250×50 φ1800	250×70 φ1800	300×70 φ2800
扁钢平弯	180×20 φ500	200×35 φ600	250×30 φ1000	250×40 φ1000	350×50 φ900	400×60 φ2000	450×70 φ1000	500×80 φ1200	500×100 φ1600
方钢	50×50 φ500	60×60 φ600	70×70 φ800	90×90 φ1200	110×110 φ1500	130×130 φ1800	145×145 φ2000	165×165 φ2200	200×200 φ2500
元钢	φ60 φ600	φ70 φ700	φ80 φ800	φ100 φ1000	φ125 φ1200	φ150 φ1500	φ170 φ1700	φ190 φ1900	φ220 φ2200
元管	φ76 φ700	φ100 φ1100	φ142 φ1800	φ170 φ2000	φ190 φ2500	φ220 φ3000	φ300 φ4000	φ330 φ5000	φ400 φ6500
方管	65×62)	90×52)	100×6.52)	120×82)	150×82)	180×102)	200×132)	250×132)	300×13.2)
工字钢	—	100 φ800	120 φ900	160φ1100	200 φ1500	240 φ2000	280 φ2000	320 φ2200	500 φ3000
槽钢外弯	140×603) φ600	160×653) φ800	200×753) φ900	300×1003) φ1100	3603 φ1200	4503) φ2000	5003) φ2000	5503) φ2200	6003) φ1500
槽钢内弯	140×603) φ800	160×653) φ1000	200×753) φ1000	300×1003) φ1100	3603) φ1400	4503) φ3000	5003) φ2000	5503) φ2200	6003) φ1500
H型钢	—	—	—	120 φ3500	180 φ4500	200 φ9000	220 φ9600	240 φ11000	320 φ32000
	—	—	—	120φ2800	160φ3200	180φ4600	200φ5200	220φ5600	300φ9600
截面模量	18-25	30-40	45-50	95-110	180-320	300-600	400-700	600-1000	900-1500
电机功率	5.1/5.5	11	11	15	30	37	64	67	67

结构概述

为弧线下调式三辊型材弯曲机,该机可一次上料完成各种型材的卷圆、卷弧、和校圆等功能。(注:卷制型材精度要求较高时需配制专用模具,精度适当放宽可使用通用模具完成卷制。)

该机床身采用钢板焊接件,均经过退回火等热处理工艺,为一封闭式框架结构,上辊位置固定,两下辊可围绕固定回转中心作弧线升降运动,三辊均为主动辊,其动力由液压马达提供,可进行正反方向旋转;两下辊的升降为液压传动、传动平稳、安全可靠;在上辊的两侧设有托辊装置有利于控制型材的卷制精度。两下辊配有显示装置。

控制部分

三辊全驱动系统

机器的上下工作辊均为主动辊。这样可以避免卷制过程中可能产生的“打滑”现象。上下工作辊的线速度由液压系统在卷制过程中自动匹配。设备回转运动均装有制动装置,以确保工作卷制时的准确定位。该装置运转平稳,卷制灵活可靠。

液压系统

液压系统的主要作用为驱动上下辊的旋转运动、两侧辊升降运动、托辊的跟踪等。整个液压系统设计合理、工作可靠,并配备高精度的吸油和回油过滤器,以保证系统油液的清洁度。油缸阀组、液压管路均采用冶金矿山用的快装接头,有可靠的径向密封,保证整个液压系统无渗漏现象。

液压系统中的主要阀组均采用台湾北部精机的优质产品。泵、滤油器、马达、密封件均采用国内名牌厂家的产品,其性能稳定、质量可靠。所有的液压件进厂前均经过雅阁试验、筛选,做到提前消除故障隐患。

技术规格以及标准配置

3轴由液压马达与行星减速机分轴驱动

钢结构床身并消除应力

特殊硬化并研磨而成的轴

标准硬化处理模具(扁钢、角钢和方钢等都可以弯曲)

可移动操作台

卧式和立式工作方式

数显(3组)

双向液压侧导轴

双速工作系统

标准3+3手动侧支撑

特殊设计箱体转换型机器,上轴可上下移动,两下轴可以左右移动

可为薄料及高精度材料进行压力调节

可选配置

无级变速调节

3+3液压支撑

NC自动化操控

各种型号的管材、型材模具以及HEB、IPN和UPN梁附件均可按客户需求提供

TECHNICAL SPECIFICATIONS AND STANDARD ACCESSORIES

Three rolls are planetary hydraulic powered

Steel construction welded frame

Special hardened and ground shafts

Hardened standard rolls (flat bar, angle, solid square etc..can be bent)

Mobile Control Panel

Horizontal and vertical working position

Digital Read-Out (3 pcs.)

2-Axis movable hydraulic lateral guide rollers

2 Speed working system

Standard 3+3 manual side supports

Special design boxer translating type machine, top roll moveable up-down, two bottom rolls moveable left-right axis

Pressure adjustment for thinner and precision materials

OPTIONAL EQUIPMENTS

Infinitely variable speed adjustment

3+3 hydraulic supports

Automation with NC and Control

NNCALL all kind of pipes, tubes, profile rolls and HEB, IPN and UPN beam attachments are available upon request